

**GAS**  
AUDIO POWER

**MAD** USER MANUAL



**MAD** S2  
S2-104 / S2-124

**MADE TO PLAY LOUD**

## **WE PLAY LOUD!!**

We know what you want. You want it LOUD, and that is exactly what we do, what we live for. Vibrations, gut-punches and straight up loud music - that's what makes us tick. We won't dress up in fancy words or claim to be something we're not. We are the NO BULLSH!T car audio brand!











Every single product with the GAS logo on it is born out of passion, the same that has driven us for two generations and that will keep us rolling up to your neighbourhood, winning and pushing the limits for many generations to come!

It's up to you to choose your own level of loud, and if you don't like what we do that's OK. You are welcome back when you've had your first true GAS experience. We don't exclude, we don't judge and we do not make up any excuses for who we are.

We are GAS and we are proud to be LOUD!

# **GAS**

# TABLE OF CONTENT

 SAFETY.....	3
 UNPACKING.....	4
 DIMENSIONS.....	4
 SPECIFICATIONS.....	5
MAD S2-104.....	5
MAD S2-124.....	5
 PERFORMANCE.....	6
Thiele/Small parameters.....	6
Impedance vs frequency.....	6
 FEATURES.....	7
Molded polypropylene cone.....	7
USG™ construction.....	7
DVS™ ventilation system.....	7
Enclosure optimized.....	7
MAD design.....	7
 HOW TO.....	8
Install subwoofer.....	8
Build enclosure.....	9
Do I need polyfill?.....	10
 TROUBLESHOOTING.....	11
No power/sound.....	11
Unwanted noise.....	11
Distortion.....	11
 WARRANTY & DISPOSAL .....	12
 THE GAS WORLD.....	13



# SAFETY

**PLAY LOUD but play safe. Read through this information, follow the instructions and save the manual for future usage and reference.**

Make sure to pay attention to the instructions when you see this symbol: 

Do not expose your new subwoofer to excessive damp or moisture. If the subwoofer is exposed it might result in electric failure, shock or damage to the product. Servicing is required when the product has been damaged in any way and/or doesn't operate normally. Refer all servicing to qualified service personnel only.

Keep the cables inside the vehicle separate from sharp edges or components that may be affected or take damage. Follow the recommended cable sizes and always use high quality cables and accessories. Even if you're eager to put the subwoofer to use - take no shortcuts when installing the cables, make sure that all connectors are protected and secured.

Do not drill any holes without checking what lies beneath, and don't cut anything without making sure that no important components risk being damaged.

There is a first time for everything, if you need help - ask a friend or contact your local GAS AUDIO POWER dealer/installer.

We want you to experience your product's MAD sound, but we don't want you to injure yourself or others. Use common sense, respect high pressure levels and volume, and follow your local laws and regulations.



# UNPACKING

Unboxing your new MAD product is an experience, make sure that the subwoofer and all the accessories are included in the packaging:



Subwoofer



Manual



Screws  
(8pcs)

# DIMENSIONS

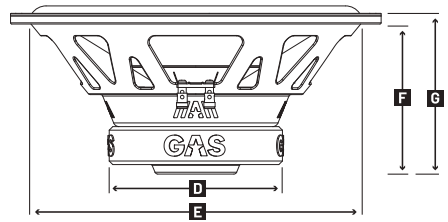
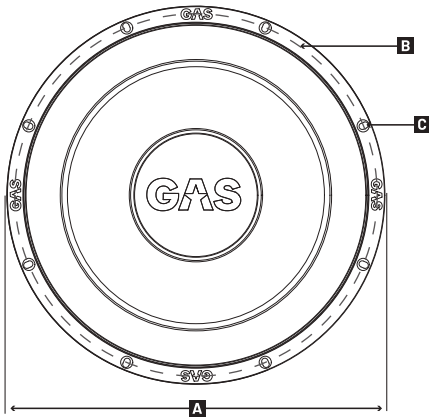

	A	B	C	D	E	F	G	
S2-104	Ø257	Ø245	5.2x7.8	Ø146	Ø231.2	118.5	126	mm
S2-124	Ø312.4	Ø299	5.2x7.8	Ø146	Ø278	126.5	135.5	mm



# SPECIFICATIONS

Below you'll find the specifications that has been checked and tested in our workshop. The specified sensitivity isn't directly connected with the sound pressure in the vehicle, and shouldn't be used as the sole indicator for comparison with other subwoofers.

<b>MAD S2-104</b>	
Component	Subwoofer
Size	10" (250mm)
Nominal Impedance	4 Ohm
Power RMS	300W
Power MAX	600W
Freq. response	25-200Hz
Voice Coil	2" (51mm) PCW
Cone	IMPP
Dustcap	3D IMPP
Basket	M Steel
Magnet	HQ Ferrite
Suspension	USG™ Rubber

<b>MAD S2-124</b>	
Component	Subwoofer
Size	12" (300mm)
Nominal Impedance	4 Ohm
Power RMS	350W
Power MAX	700W
Freq. response	20-200Hz
Voice Coil	2" (51mm) PCW
Cone	IMPP
Dustcap	3D IMPP
Basket	M Steel
Magnet	HQ Ferrite
Suspension	USG™ Rubber

# PERFORMANCE

## THIELE/SMALL PARAMETERS

	S2-104	S2-124
<b>Impedance</b>	4 Ohm	4 Ohm
<b>Re</b>	3.2 Ohm	3.2 Ohm
<b>Fs</b>	30Hz	28Hz
<b>Qms</b>	4.21	4.46
<b>Qes</b>	0.49	0.56
<b>Qts</b>	0.44	0.48
<b>Vas</b>	46.7 L	95.4 L

	S2-104	S2-124
<b>Cms</b>	0,30mm/N	0,29mm/N
<b>Mms</b>	98.9g	127.9
<b>Le</b>	1.069mH	1.103mH
<b>Xmax</b>	17mm	17mm
<b>dB/SPL</b>	86dB 1W/1M	87dB 1W/1M
<b>Bl</b>	11.4	10.5
<b>Driver Vol. Displacement</b>	1.2 L	2.2 L

## IMPEDANCE VS FREQUENCY

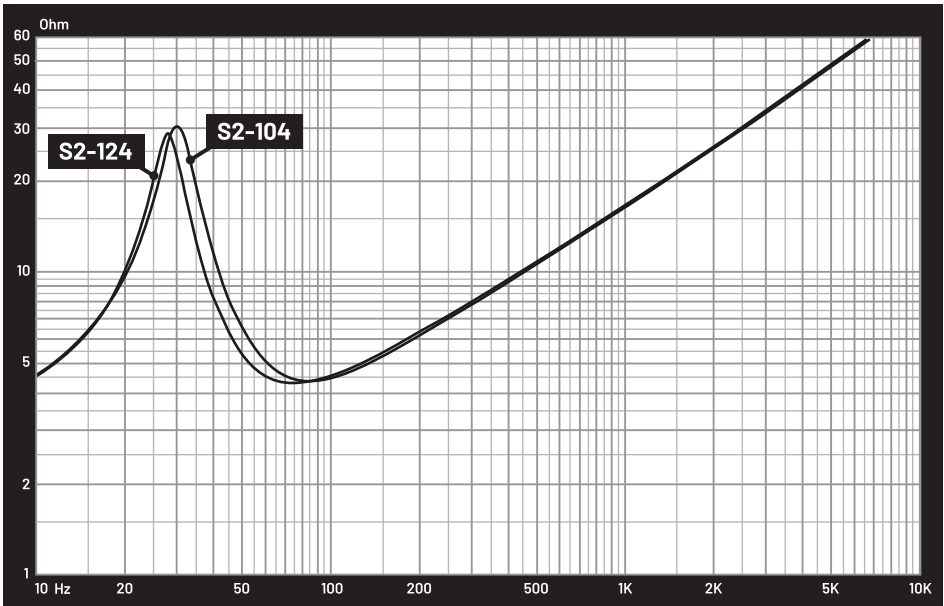

# FEATURES

The MAD subwoofers are made to be LOUD and last for years to come. Those awesome vibrations are what drives us to create impressive subwoofers. We want to help you and your vehicle to be as LOUD as possible. We've made sure that is the case by using innovative and groundbreaking techniques that increase durability.

## MOLDED POLYPROPYLENE CONE

We wanted to make the MAD S2 series really LOUD, and that demands a tough cone. The cone on the S2 series is made by injection molded polypropylene that withstands the toughest resonance and membrane break-up - even at really high SPL levels. Provide it with raw power and you will be awarded!

## USG™ CONSTRUCTION

Next we turned our attention to the build around the cone where we developed a USG™ (Unity Surround & Gasket) construction. Normally the gasket and surround are divided into two separate parts. We combined these to optimize the linear movement and the cone displacement area to give you the extra edge in accuracy and provide an awesome musical performance.

## DVS™ VENTILATION SYSTEM

If you like it LOUD, proper cooling is key. We implemented the subwoofer with a DVS™ (Dual Ventilation System) for reduced distortion and increased heat dissipation. Proper cooling means reduced heat, and reduced heat gives you the option to add more subwoofers and get an even bigger sound!

## ENCLOSURE OPTIMIZED

MAD S2 series is both loud and impressive. We created a subwoofer with multitalented Thiele/Small parameters that ensures great performance in both sealed, vented and band pass enclosures. Fit the enclosure with polyfill to lessen the BOOM and bring out the BASS!

## MAD DESIGN

To finalize the subwoofer's high quality construction, we created an industrial and rugged MAD shaped steel basket that is resilient and tough. The 51mm voice coil is made of PCW (Pure Copper Wire) and the dust cap is, like the cone, made of IMPP for a unique 3D design that will make your friends jealous and keep the haters away! Walk tall & cruise with pride!





# HOW TO

## INSTALL SUBWOOFER

Before installing your brand new subwoofer, make sure that you have everything you need. Have the right tools ready, and make sure that you have the necessary knowledge/skill to perform the installation properly. Preparation and knowledge is crucial!

The MAD S2-104/S2-124 uses a single 4 Ohm voice coil. If you want to connect two or more S2 series subwoofers, you can vary the impedance by altering the wiring configuration to use a series, parallel or series-parallel setup. The more the merrier!

Make sure to look through the recommended wiring schematics below and choose the setup that corresponds with the number of subwoofers in your sound system. Take note of the impedance stability of your amplifier. Don't be afraid to consult your local GAS AUDIO POWER dealer/installer if you have any questions.

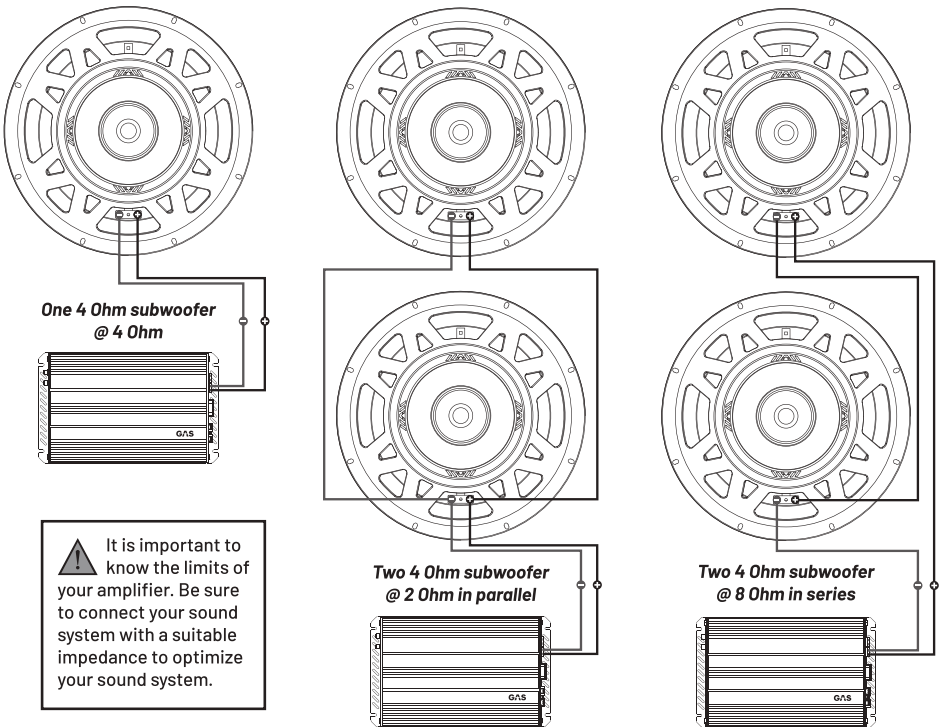

# HOW TO

## BUILD ENCLOSURE

If you want a LOUD and awesome looking sound system, you should mount your MAD subwoofer in an enclosure. Here's information about optimized volumes for different types of enclosures and how they perform with the MAD S2 subwoofer. If you feel unsure about how to build an enclosure on your own, consult a local GAS AUDIO POWER dealer/installer.

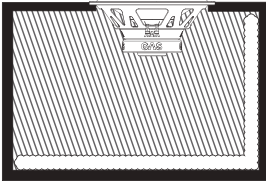

**SEALED**

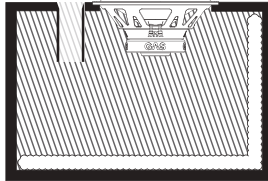

**VENTED**

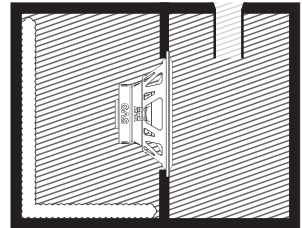

**4TH ORDER BANDPASS**

### MAD S2-104:

	VOLUME	F3	QTC	FB	PORT	LENGTH	BANDWIDTH
<b>SEALED</b>	15L	53Hz	0.849	x	x	x	x
<b>SEALED</b>	25L	50.7Hz	0.707	x	x	x	x
<b>VENTED</b>	35L	35Hz	x	36Hz	1x3" (76mm)	260mm	x
<b>4TH ORDER BANDPASS</b>	SEALED 26.5L VENTED 30.5L	x	x	52Hz	4" (102mm)	265mm	(-3dB) 36Hz-74Hz

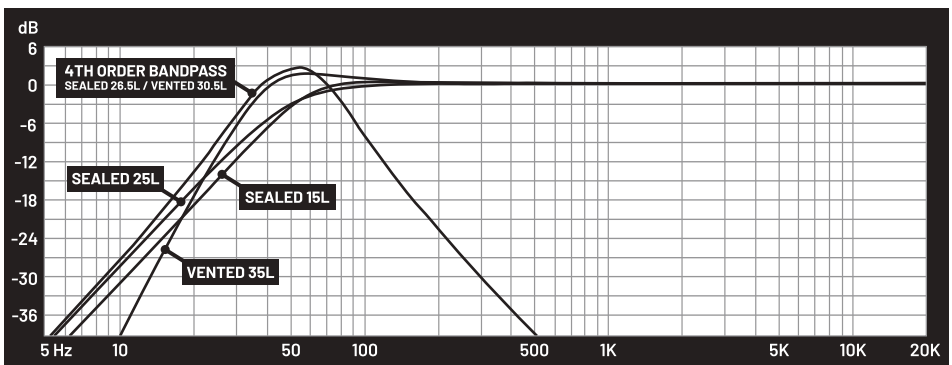

# HOW TO

## MAD S2-124:

	VOLUME	F3	QTC	FB	PORT	LENGTH	BANDWIDTH
SEALED	27L	52Hz	0.784	x	x	x	x
SEALED	36L	49.3Hz	0.707	x	x	x	x
VENTED	45L	38Hz	x	38Hz	1x4" (102mm)	380mm	x
4TH ORDER BANDPASS	SEALED 37L VENTED 63L	x	x	52Hz	2x4" (102mm)	270mm	(-3dB) 35Hz-71Hz

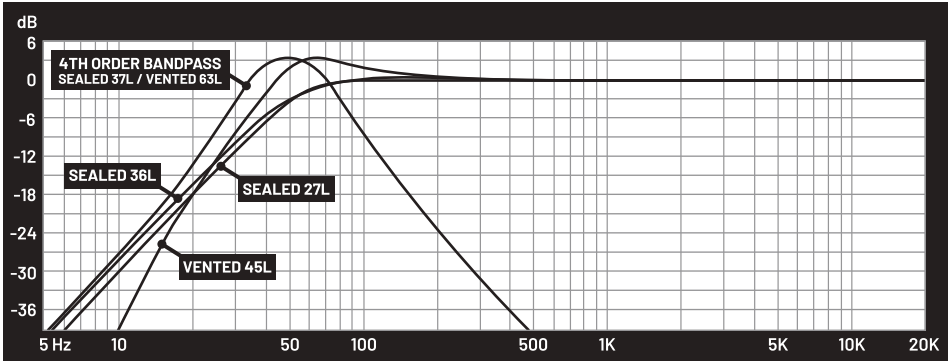

## DO I NEED POLYFILL?

Hell yeah! We recommend using polyfill for all sealed, vented and bandpass enclosures for the best overall performance.

A polyfilled enclosure will bring out the full potential of your subwoofer, by starting an isothermal process when energy flows through the fibers (very scientific). This means that the air gets more dense, so it lessens the BOOM and brings out the BASS! It can also reduce harmonic distortion. Sounds complicated, we know. But it's easy to do! Cover two sides in a ported enclosure or make a loose polyfill ball behind the driver in a sealed enclosure. Try it out! If you like the bass to hit harder - just take away some. Do you want to lessen the effect? Put in some more.

# TROUBLESHOOTING

## NO POWER/SOUND

Check the subwoofer to make sure it isn't damaged. If your subwoofer doesn't get any power, the most common issue is either in the wiring or in the amplifier. Use a multimeter to measure the amplifier's voltage on the +12V terminal and the remote signal terminal. Use a multimeter to make sure that you have a negative ground connection. Check the built-in fuse (if there's one) on the amplifier. If there's no power coming through - control the fuse on the power cable. If this is intact - make a full check of the wiring to ensure cable integrity.

Check all the speakers connected to your sound system. Check all the speaker cables and all the signal cables. Check your head unit to make sure no settings are limiting the amplifier's functions or the subwoofer. When all of the above has been tested/looked over, and all is as it should be but there's still no sound, consult your local GAS dealer.

## UNWANTED NOISE

Start by looking over the subwoofer and other speakers in the sound system so there is no damage or connection issue with the wiring. Make sure that your signal cables or speaker cables aren't too close to the power cables. Check your amplifier's grounding point and make sure that the surface is clean. When all of the above has been tested/looked over, and the unwanted noise does not vanish, consult your local GAS dealer

## DISTORTION

Start by looking over the subwoofer and other speakers in the sound system so there's no damage or connection issue with the wiring. Check the speaker cables to make sure that the polarity isn't reversed on one channel. Check the settings on the amplifier, make sure that the gain/level is set according to the amplifier's instructions. If your amplifier has a boost function, lower its effect or turn it off.

# WARRANTY & DISPOSAL

This product is covered by warranty, depending on the conditions in the country where it's sold. If the subwoofer is returned for service, please include the original dated receipt (or a copy) with the product. Make sure that the subwoofer is packaged properly and secured, preferably in its original packaging.



The crossed-out wheeie bin symbol means that the product, literature and packaging included must be taken to separate collection at the end of their working life. Don't dispose of these products as unsorted municipal waste: take them for recycling. For info on your nearest recycling point, check with your local waste authority.



This product has been granted with the CE certification mark to show that the product follows the health, safety, and environmental protection standards for products sold within the European Economic Area (EEA).



GAS Audio Power products comply with the relevant provisions of the RoHS Directive for the European Union. In common with all Electrical and Electronic Equipment (EEE) the product shouldn't be disposed of as household waste. Alternative arrangements may apply in other jurisdictions.



GAS Audio Power is a global partner of the European Mobile Media Association, an organization that focus on promoting the custom made mobile media installations to consumers.

# THE GAS WORLD

You've entered the world of GAS. We aim to please, and we've made sure to have products made for you. No matter what stage of the LOUD-addiction you might find yourself in, there is a GAS product to fill your need.

## ***MAD***

Just starting out? The MAD series is made to play LOUD and to be the express lane to a no bullsh!t sound system that will make sure everyone can hear you coming!

## ***MAX***

The MAX series holds products made to deserve the center stage. Powerful, heavy duty and designed to be noticed. We made NO COMPROMISES because we know that you wouldn't accept it.

## ***CMP***

The CMP series has been developed for the crucial seconds when the dB-counter starts to tick. All CMP products have hand-picked, high quality, COMPETITION GRADE components and they are specially designed to withstand an awesome amount of power.



# THANKS FOR JOINING GAS AUDIO POWER!



**GAS**  
**AUDIO POWER**

GAS AUDIO POWER and SHAKY are registered trademarks by Winn Scandinavia AB and is protected by relevant laws and jurisdictions such as Copyright and Trademark laws.

Winn Scandinavia AB | Adolfsbergsvägen 6, 70227 Örebro, Sweden | [www.winnscandinavia.com](http://www.winnscandinavia.com)

Winn Scandinavia AB reserves for possible typos, factual or numeric errors that may have been printed on any products, package designs, user manuals and/or other included accessories.

**GAS**  
AUDIO POWER