

Introduction and Features

The RPK4-CH4101 is a complete radio replacement kit with integrated climate control retention for the 2013-2019 RAM trucks equipped with the 8" screen. All modules and cables are included to retain important features of the factory system including: steering wheel mounted radio controls, factory reverse camera, and AM/FM reception.

A secondary 5.2" LCD screen is added for additional vehicle control including: Climate Controls user interface retention, vehicle settings retention, factory amplifier control, settings for control of the RPK4.2-CH4101 interface, forced camera activation, ability to add additional cameras, tire pressure and vehicle gauges. Features provided by the LCD screen will vary based on the vehicle features. See Important Notes (next section) for additional information.

Four hard buttons added to the radio dash bezel (below the 5.2" LCD screen) allow user to set presets to control functions including: specific climate controls, forced camera activation, LCD screen controls. Options for hard buttons will vary based on vehicle features and which cameras are installed.

Some advanced features require additional accessories, sold separately.

Important Notes

We recommend reading this manual thoroughly to familiarize yourself with the entire process prior to beginning the installation.

1. Only compatible in vehicles equipped with the 8" screen.
2. 2019 RAM Trucks: Only compatible with Classic body style.
3. Does Not Retain:
 - **Cluster Display Features**
 - Compass
 - Clock
 - Phone pop-ups
 - Navigation pop-ups
 - **uConnect Features**
 - WiFi-Hotspot
 - SOS / Assist
 - **Factory Amplifier Features**
 - Speed Controlled Volume
4. In trucks equipped with parking sensors you must use the included external speaker in order to continue hearing parking sensor chimes. If the truck has a factory amplified system and parking sensors, the speaker is not necessary unless the factory amplifier is no longer being used.
5. **If you are adding additional cameras, or the truck has additional factory cameras beyond reverse cam, PAC part number RPA-16P5V (sold separately) must be used to connect up to 5 total cameras.**



Components

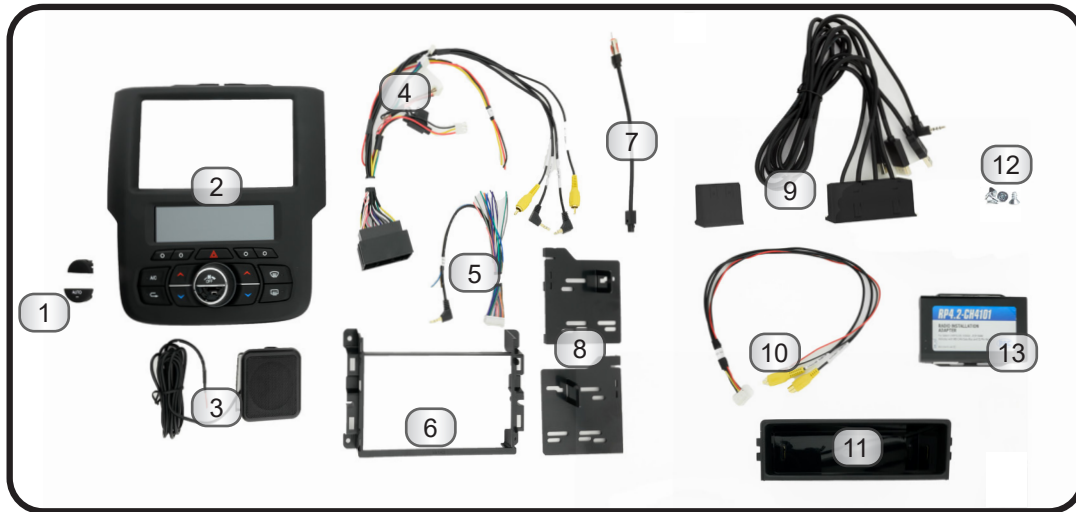

Tools needed for installation:
Phillips head screwdriver,
7mm socket, ratchet, T20 torx
screwdriver, plastic panel removal
tool (example - PAC part number
TL-PRY2), air saw or hacksaw with
metal cutting blade (unless you are
installing a shallow mount radio;
details on page 6).

1. *Climate Control Button Inserts*
2. *Radio Dash Bezel with 5.2" LCD Display*
3. *External Chime Speaker*
4. *RP4.2-CH4101 Interface Harness*
5. *RP4.2-CH4101 Aftermarket Radio Connection Harness*
6. *Radio Mounting Shroud*
7. *AM / FM Antenna Adapter (BAA22)*
8. *Radio Mounting Brackets*
9. *OEM USB Replacement Hub**
10. *Reverse Camera Retention Harness (RPA-16P1V)*
11. *Single DIN Mounting Pocket*
12. *Radio Mounting Screws*
13. *RP4.2-CH4101 Radio Replacement Interface*

*Some kits include a USBDMA6 and instructions for how to obtain a USB Hub Replacement.

Installation

Part One: Disassembly of Factory Dash

Trucks With a Center Console

If your truck has a center console, begin here. If not, skip ahead to page 4



Step 1

Remove the circled rubber inserts to gain access to the screws securing the dash and console in place.



Step 2

Remove the two T-20 torx screws from the top of the dash.



Step 3

Remove the T-20 torx screw from the back of the small pocket on the right side of the dash.

Part One: Disassembly of Factory Dash (cont.)



Step 4

Remove the two Phillips head screws in the tray at the bottom of the dash panel.

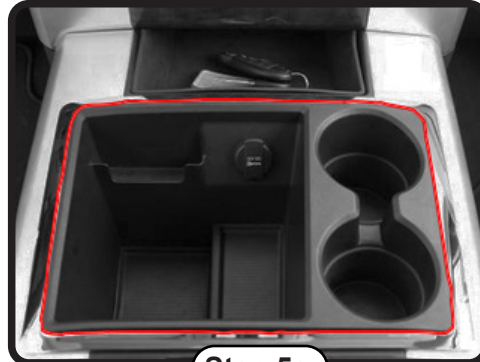

Step 5a

2013-2015 models: Remove the chrome trim ring around the center console storage compartment.

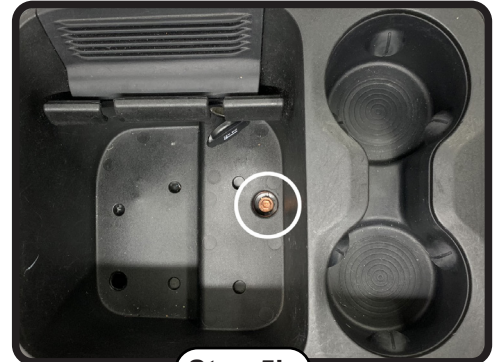

Step 5b

2016-2019 models: Remove the rubber insert in the bottom of the center console storage compartment. Remove the 7mm screw from the bottom of the storage compartment.



Step 6

Remove the center console by pulling straight up from the back then pulling the console outward toward the back of the truck.



Step 7

Remove the dash panel by gripping firmly and pulling straight out on the top portion of the panel.

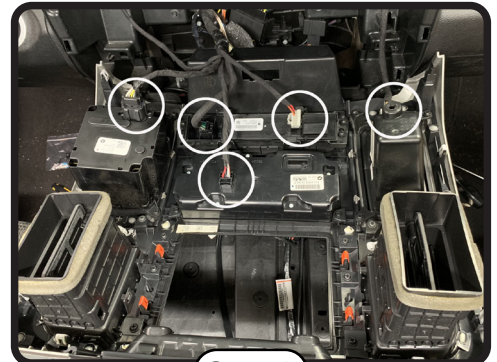

Step 8

Disconnect the harnesses from the back of the dash panel. Once all harnesses have been disconnected, remove the dash panel from the truck.

Part One: Disassembly of Factory Dash (cont.)

Trucks Without a Center Console



Step 1

Remove the circled rubber insert to gain access to the screws securing the dash in place.



Step 2

Remove the two T-20 torx screws from the top of the dash.



Step 3

Remove the T-20 torx screw from the back of the small pocket on the right side of the dash (not always present).



Step 4

Remove the dash panel by gripping firmly and pulling straight out on the top portion of the panel.



Step 5

Disconnect the harnesses from the back of the dash panel. Once all harnesses have been disconnected, you can remove the dash panel from the truck.

This is the end of part one. Please continue to the next page to begin part two.

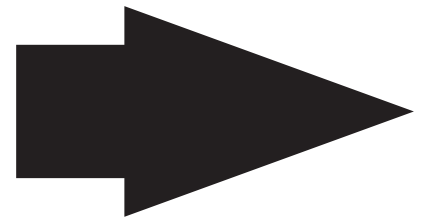

Part Two: Radio removal / Dash preparation

Removing the Radio



Step 1

Remove the four 7mm screws securing the radio in place.



Step 2

Disconnect the 52-pin dock and lock connector and all of the antennas from the radio (the number of antenna connections will vary based on the vehicle's available features).



Step 3

Remove the radio from the dash (dash appearance may vary according to model year).

Relocating the Factory Security Module (If present, not necessary if installing a shallow mount radio)

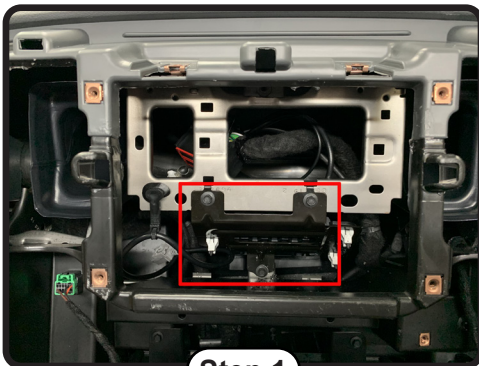

Step 1

If your truck is equipped with the factory security module shown here, it is necessary to relocate the module to allow for the removal of the lower portion of the metal support bracket.

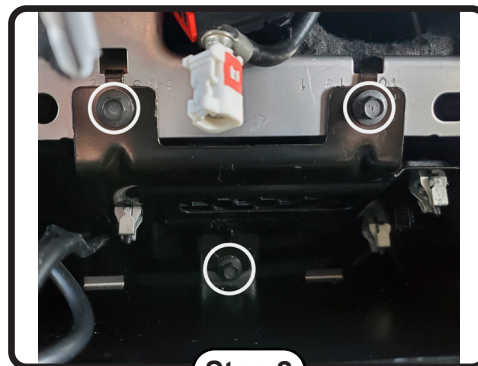

Step 2

Remove the three 7 mm screws circled here and set aside.

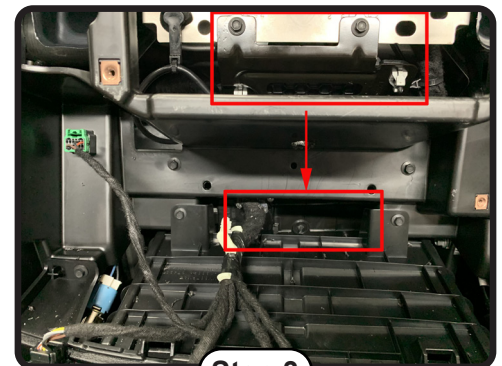

Step 3

Relocate the security module to just below the plastic support beam shown here.

Part Two: Radio removal / Dash preparation (cont.)

Cutting the Sub-Dash (Not necessary if installing a shallow mount radio)



Step 1

Cut here in 2013-2017 model years.

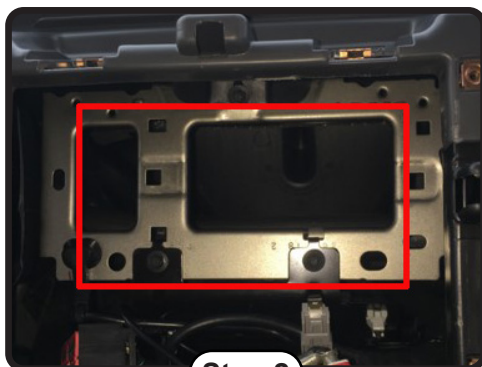

Step 2

Cut here in 2018-2019 model years.
It is necessary to cut more metal out
of these models.



Step 3

After cutting, the sub dash should
look similar to this.

This is the end of
part two. Please
continue to the next
page to begin part
three.

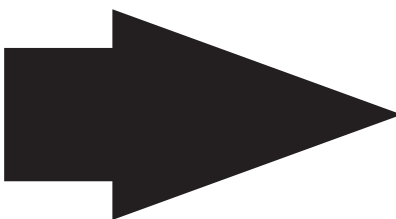

Part Three: Installing the New Dash Panel



Step 1

Now we are going to remove the portion of the dash outlined in red and replace it with the new PAC dash bezel.

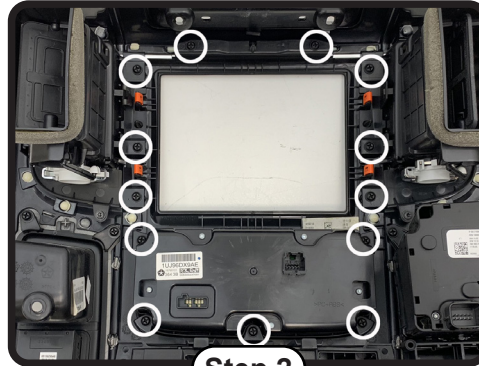

Step 2

Remove the 13 phillips head screws holding the dash bezel onto the dash panel. Retain these screws as they will be used to secure the new dash bezel into the dash panel.



Step 3

To remove the factory dash bezel, flip the panel back over and pull straight out at the bottom of the bezel, then down.



Step 4

Your dash panel should now look like this. You should also have 13 phillips head screws retained from step 2.



Step 5

Next you must install the appropriate insert (Auto or Blank) in the middle of the fan speed knob on the new dash panel. Please be sure to choose the proper insert as changing them out after one has been inserted can be challenging.

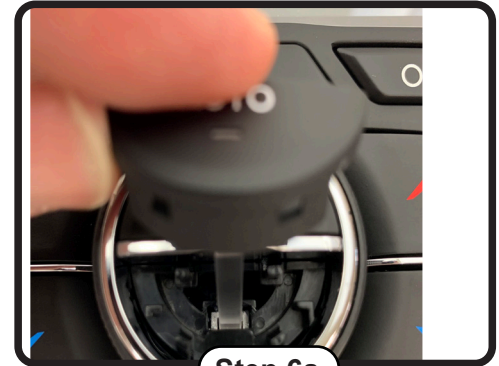

Step 6a

If you have Automatic Climate Controls, install the insert that says "Auto". Be sure to line up the light pipe with the hole in the kit. Please note that if your truck did not have automatic climate controls with the factory panel, inserting this button will not add that functionality.

Part Three: Installing the New Dash Panel (cont.)



Step 6b

The insert should look like this when installed properly.



Step 6c

If you do not have auto AC then install the blank insert. The insert should look like this when installed properly.



Step 7

Insert the new dash bezel by placing the top in first then sliding it up into place.

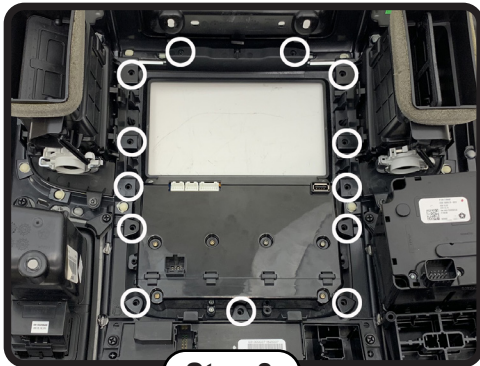

Step 8

Now secure the new dash bezel into place by reinstalling the 13 Phillips head screws removed in step 2.



Step 9

Your dash should now look like this.

This is the end of part three. Please continue to the next page to begin part four.

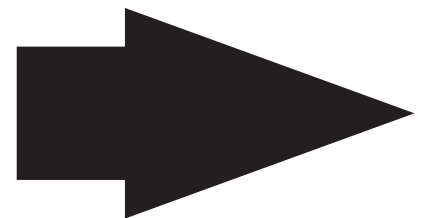

RPK4-CH4101

Complete Radio Replacement with
Integrated Climate Control Retention for Select
2013-2019 RAM Trucks

Mounting the Aftermarket Radio

Double-DIN

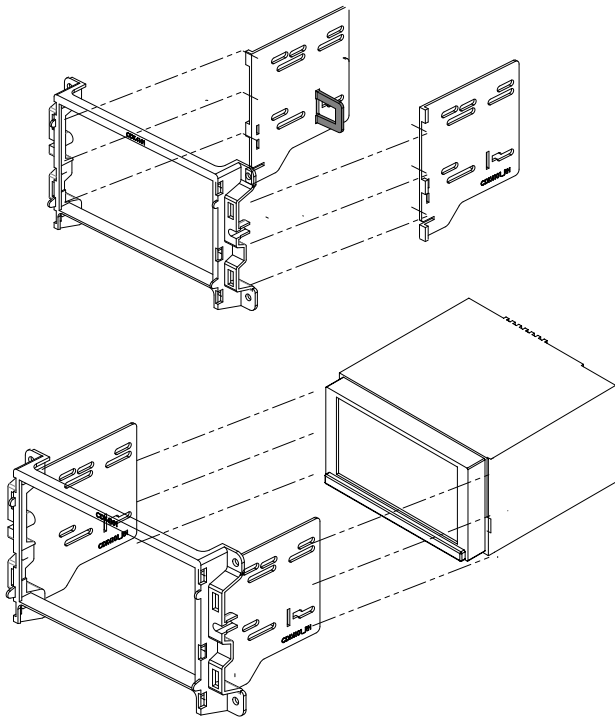

Single-DIN

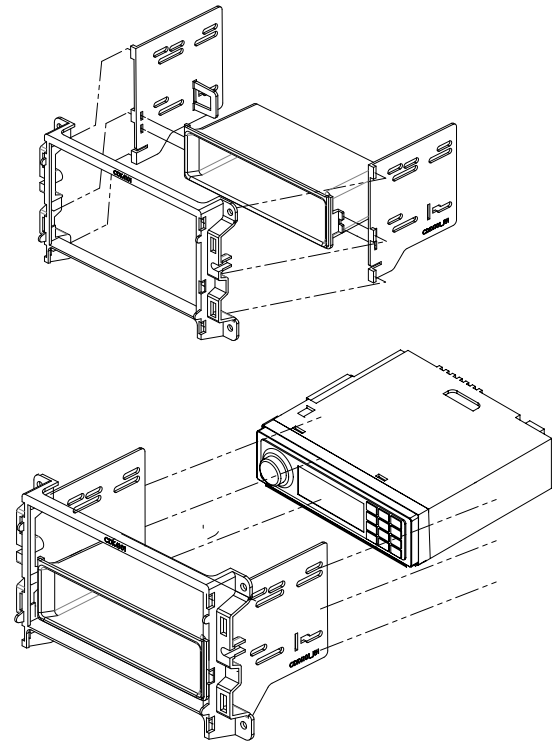

Part Four: Configuring and Wiring the RadioPRO Interface

RP4.2-CH4101 Module Layout

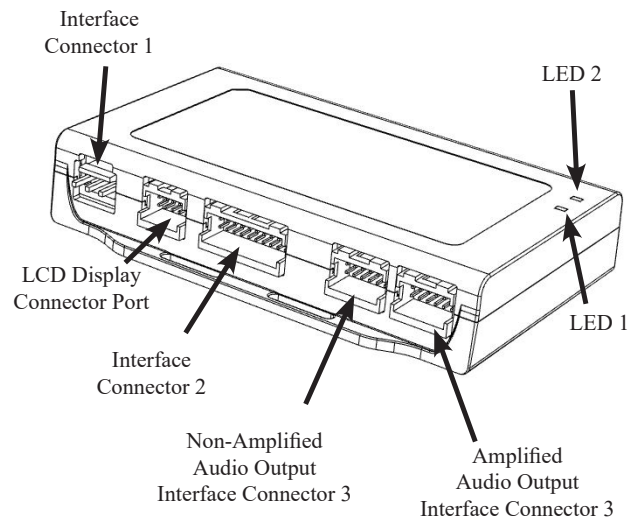
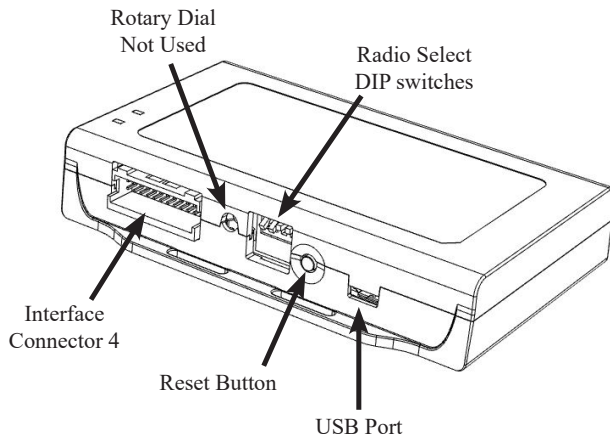

Part Four: Configuring and Wiring the RadioPRO Interface (cont.)

Connectors

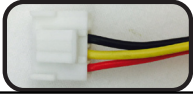

Interface Connector 1

Red	Accessory Output (10A)
Yellow	12v+
Black	Ground



Interface Connector 2

White / Red	HS-CAN + Input
White / Black	HS-CAN - Input
Pink	MS-CAN + Input
Pink / Black	MS-CAN - Input
Blue / White	Not Used

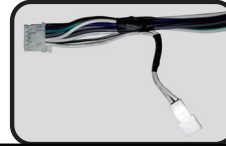

Interface Connector 3

White	Front L + output
White / Black	Front L - output
Gray	Front R + output
Gray / Black	Front R - output
Green	Rear L + output
Green / Black	Rear L - output
Purple	Rear R + output
Purple / Black	Rear R - output
Ext Speaker Out	Connect to supplied external speaker when installing this kit into a vehicle that has factory parking sensors

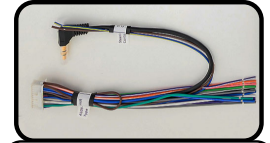

Interface Connector 4

Purple	Rear R + input
Purple / Black	Rear R - input
Green	Rear L + input
Green / Black	Rear L - input
Gray	Front R + input
Gray / Black	Front R - input
White	Front L + input
White / Black	Front L - input
Blue / Yellow	SWC Output / Key 1
Brown	SWC Output / Key 2
3.5 mm Jack	SWC Output
Pink	Vehicle Speed Sense Output
Light Green	Parking Brake Output
Violet / White	Reverse Signal Output
Orange / White	Illumination Output
Blue / White	Amp Turn On Input
Blue	Not Used

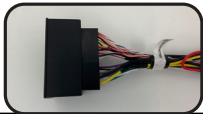

Vehicle Connector 1

Yellow	Battery +12v
Black	Ground
Pink	MS-CAN +
Pink / Black	MS-CAN -
White / Red	HS-CAN+
White / Black	HS-CAN-
White	Front L + input
White / Black	Front L - input
Gray	Front R + input
Gray / Black	Front R - input
Green	Rear L + input
Green / Black	Rear L - input
Purple	Rear R + input
Purple / Black	Rear R - input
Reverse Camera	Video from factory reverse camera
Cargo Camera / RSE Video	Video from factory cargo camera
RSE Audio	Not Used
OEM AUX Audio	Audio from factory Auxiliary Input Jack



LCD Display Output Connector



Reverse Camera Retention Harness

Red	Aftermarket Camera Acc 12v+ Output (800 mA)
Black	Aftermarket Camera Ground Output
Yellow Composite Male	Camera Out To Aftermarket Radio
Yellow Composite Female	Camera In From Vehicle Connector

DIP Switches

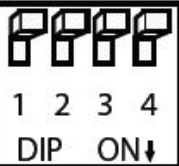

Set DIP switches that correspond with your radio to the ON position. Set all other DIP switches to the OFF position.



Alpine	JVC	Kenwood / Lightning Audio	Clarion / Nakamichi / Stinger	2-Wire Resistive	Pioneer / Other*	Sony	Fusion
1	2	1 & 2	3	2 & 3	1, 2, & 3	4	1 & 4

*Other - Dual / Axxera (these brands could also have 2-wire resistive), Jensen, Rockford Fosgate

The radio select DIP switches on the side of the interface must be adjusted to the proper radio setting before plugging the interface into the vehicle.

Wiring Connections

1. Set the DIP Switches on the side of the interface according to the chart on page 10.
2. Wire the aftermarket radio harness according to the wiring connection charts for Interface Connector 1 and Interface Connector 4 provided on page 10.
3. Connect Interface Connectors 1, 2 and 4 to the RP4.2-CH4101.
4. Connect Interface Connector 3 to either the amplified or non-amplified audio output connector depending on your scenario.
5. Connect one end of the supplied LCD Display connector into the Expansion Port on the RP4.2-CH4101 and run the other end to be accessible when re-installing the factory dash panel.
6. If you are installing this kit into a truck with factory parking sensors and it IS NOT equipped with a factory amplifier, or if the factory amplifier is being bypassed, connect the supplied external chime speaker to the external speaker output on interface connector 3. Mount in a place free of obstructions so that the parking sensor chimes can be heard.
7. Connect the SWC output wire to the aftermarket radio (aftermarket radio must support a wired remote input).
8. Once all connections have been made, plug the vehicle connectors into the vehicle harness.
9. Reverse camera connection (see Fig. 2):
 - a. Connect the included RPA-16P1V harness to the 16-pin connector (Connector 3) on the back of the radio dash bezel (see Fig.1).
 - b. Connect the Male Yellow RCA (Video Output) from the RPA-16P1V harness to the aftermarket radio's reverse camera input.

Fig.1: Rear of RPK4-CH4101 Radio Dash Bezel

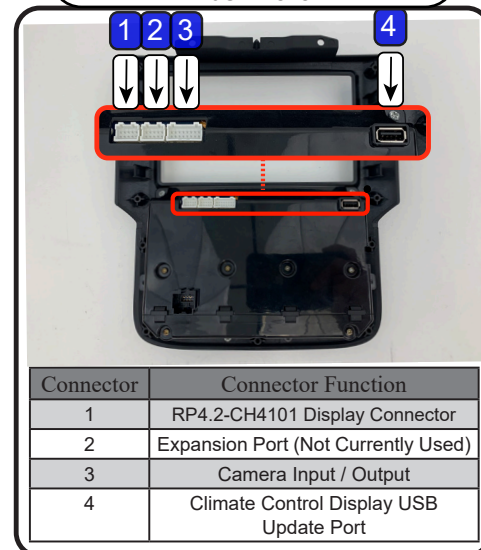
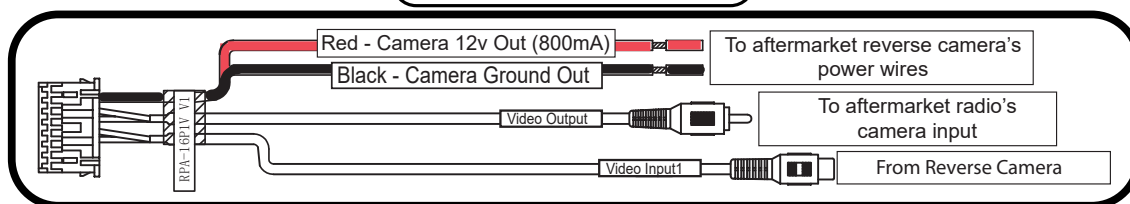

Fig.2: RPA-16P1V Harness



- c. Connect the Female Yellow RCA (Video Input) from the RPA-16P1V harness to the Male Yellow RCA from vehicle connector 1 (factory reverse camera), or to the aftermarket reverse camera's RCA video output.
 - d. Connect the red and black power wires from the RPA-16P1V to the aftermarket reverse camera's power wires. If you are utilizing a factory camera, simply insulate these wires.
 - e. **To Add Additional Cameras (Front, Blind Spot, Cargo, etc.):** use the RPA-16P5V (sold separately) in place of the included RPA-16P1V harness. See the next page for additional information.
10. Now it's time to re-install the factory dash panel into the truck. Connect the factory plugs from the vehicle into the appropriate connectors on the back of the dash panel.
 11. Connect the free end of the LCD Display connector into the outermost 10-pin connector (Connector 1) on the back of the radio dash bezel (see Fig.1).
 12. If you are retaining or installing cameras, connect the RPA-16Pxx harness into Connector 3 on the back of the radio dash bezel (see Fig. 1).
 13. OPTIONAL: To update firmware with minimal effort and without accessing the back of the Climate Control display, a USB extension cable, PAC part USBDMA3 (sold separately), can be connected into the USB port (Connector 4) on the back of the radio dash bezel (see Fig.1) and run to a location that allows for easy access (glove box, tucked under an interior panel, etc.).
 14. Once the dash bezel has been connected, the LEDs for the illumination of the four hard buttons on the kit (below the dash bezel LCD display) will illuminate momentarily, then start flashing. This indicates the system is initializing. Next, the LEDs will turn off, then the RadioPRO splash screen will appear on the LCD. **The initialization sequence can take up to 2 minutes on initial powerup.** Once the LCD screen comes on, you can proceed to the setup and testing section on the next page.

Using Multiple Cameras

With the addition of the optional RPA-16P5V harness, the RPK4-CH4101 supports display and control of up to 5 cameras. The RPA-16P5V replaces the RPA-16P1V camera harness that is included with the RPK4-CH4101.

Cameras can be connected to any of the 4 separate camera inputs (camera 1 is reserved for the reverse camera). Camera input and control is adjustable through the settings menu on the LCD display on the dash bezel. The provided power and ground connections are active when the vehicle is on. Use these leads to power your aftermarket camera(s) (up to 800mA total). If the cameras require more than 800mA, please use an external relay. See page 13 for setup and operation.

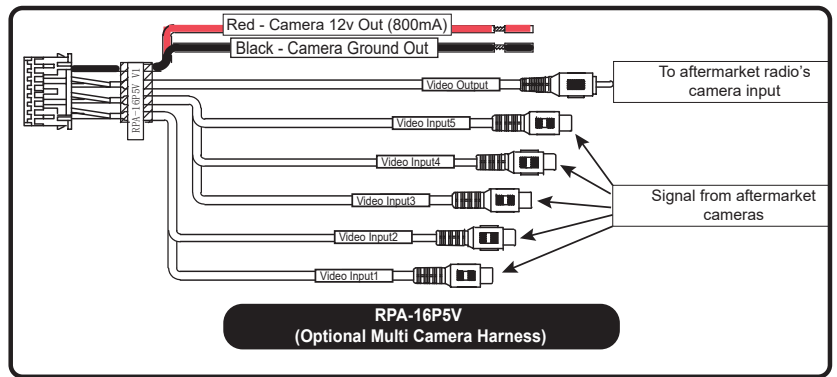

Setup and Testing

Verify that all screens and functions are present through the 5.2" display

Enter the Installation Settings menu by pressing and holding the Vehicle Settings icon on the Options screen.

Setup and Testing (cont.)

Camera Setup

The camera settings menu is used to setup which cameras are installed on the vehicle. When used with the PAC harness RPA-16P5V (sold separately), the RPK4-CH4101 gives you the ability for switching between up to 5 different camera images via the aftermarket radio. **Note: Camera 1 is permanently set as the Rear Camera and cannot be changed in the settings menu.** Camera inputs 2, 3, 4, and 5 can be toggled between "None" (no camera) or the options shown in Fig. 1 below.

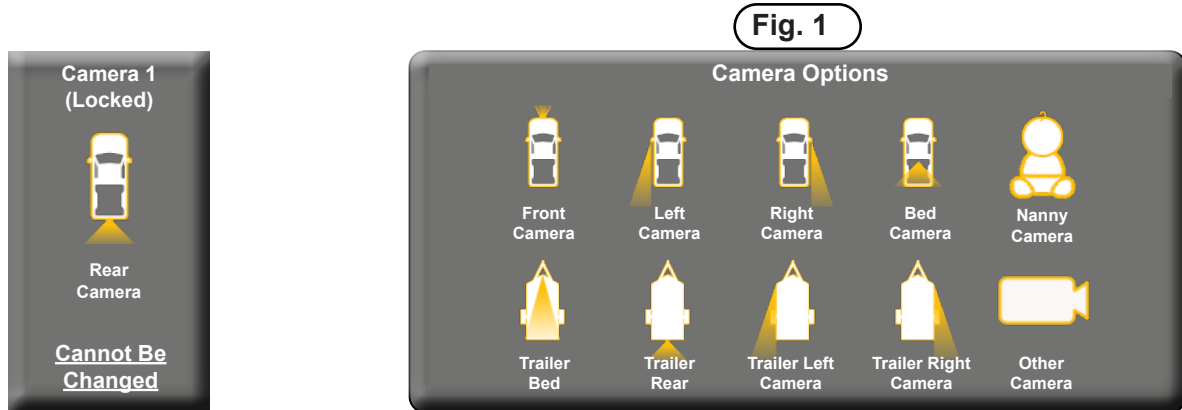

To edit the camera settings, from the Installer Settings menu, do the following:

Step 1

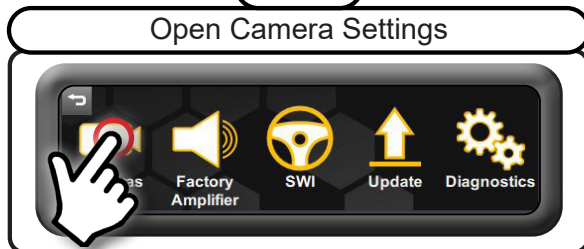

Step 2

Touch the camera input (Camera 2, 3, 4, 5) you wish to activate. The radio will display the image of the camera connected to the selected camera input.

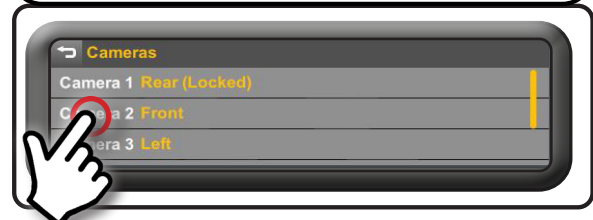

Step 3

From the set of options, touch the icon that matches the image displayed on the radio. Repeat steps 2 and 3 for each camera that is being added.

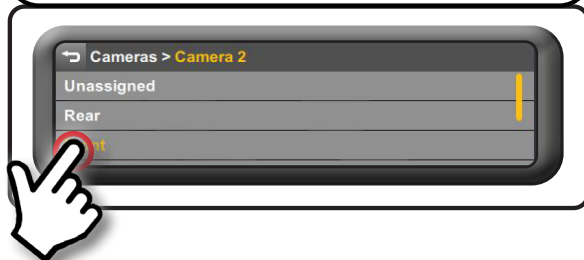

Step 4

Verify the camera input / inputs have been setup properly. Exit the settings by pressing the back button until you are on the options screen.

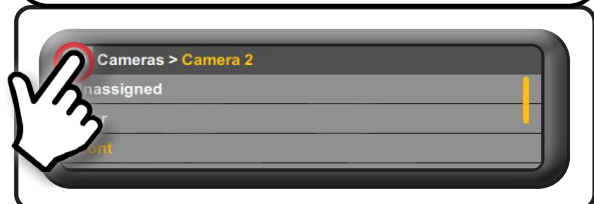

Setup and Testing (cont.)

Step 5

Swipe left to the camera control screen

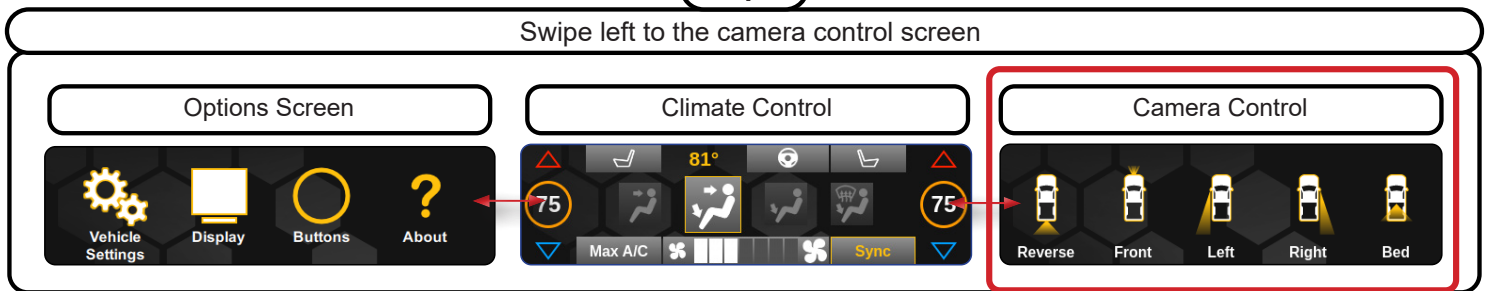

Step 6

Verify the new camera icon / icons show on the screen and activates the camera when touched.

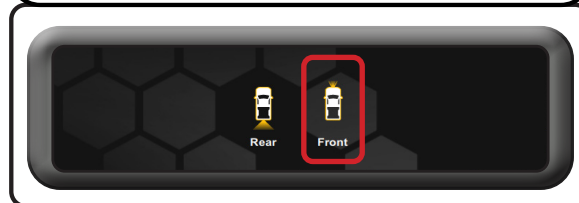

Setting Automatic Camera Triggers (Front, Left and Right Cameras Only)

Step 1

Open Camera Settings

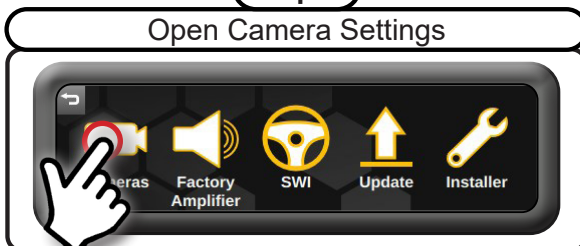

Step 2

Select Desired Camera

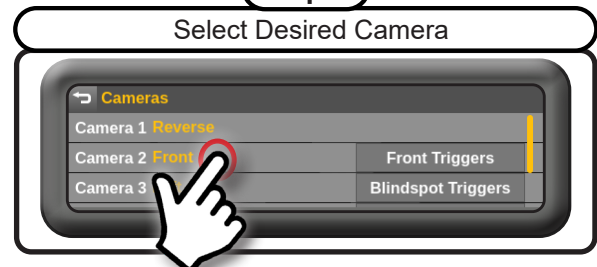

Step 3

Select the camera trigger.

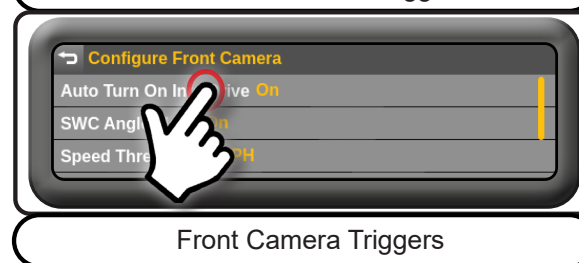

Setup and Testing (cont.)

The selectable triggers for the Front camera are:

- **Auto Turn On Into Drive** - the front camera will come on when the vehicle is placed into drive and stay on for 30 seconds or until the configured speed threshold is reached.
- **Steering Wheel Angle Mode** - The front camera will turn on when the steering wheel is greater than the selected angle and the speed is less than the selected speed threshold.
- **Speed Threshold** - The front camera will come on when the vehicle is less than the speed selected here and greater than the SW Angle speed threshold.
- **Steering Wheel Angle Threshold** - The front camera will come on when the steering wheel angle is equal to or greater than what is selected here and less than the selected speed threshold.
- **Auto Turn On Into Drive Max Time** - This sets the max amount of time the front camera will be displayed when the vehicle is put into drive. If the speed threshold is met before this time ends, the front camera will turn off then.

The selectable triggers for the Left and Right camera are:

Operation

- **Off** - Camera will not come on with turn signals (only with forced activation through icons on LCD display).
- **On** - Camera will come on with turn signal at any time.
- **Double Tap** - Camera will come on with a double tap on the turn signal at selected speed (select speed trigger).
- **Moving Over X MPH** - Camera will come on with turn signal when truck is moving faster than the selected MPH.

Speed Trigger

- **Above 10 MPH**
- **Above 20 MPH**
- **Above 30 MPH**
- **Above 40 MPH**

Steering Wheel Controls

IMPORTANT! The interface comes pre-programmed with all factory SWC functions and does not require programming unless you wish to re-assign the SWC functions, or utilize short press long press dual command functionality. See below for information on custom programming the steering wheel controls, including adding long press / short press operation.

	Alpine	JVC	Kenwood	Clarion	Pioneer	Sony	Fusion
Volume +	Volume +	Volume +	Volume +	Volume +	Volume +	Volume +	Volume +
Volume -	Volume -	Volume -	Volume -	Volume -	Volume -	Volume -	Volume -
Source	Source	Source	Source	Source	Source	Source	Source
Track +	Track +	Track +	Track +	Search +	Track +	Track +	Track +
Track -	Track -	Track -	Track -	Search -	Track -	Track -	Track -
Preset +	Preset +	Band/Disc Up	Disc/Radio +	Band	Preset +	Preset +	Audio
Voice	Mute	Mute	Mute	Mute	Mute	Mute	Mute
Phone/Answer	Receive	Receive	Off Hook	Send	Answer	Answer	Power

Note: 2 Wire Resistive radios do not have a specific default programming order and cannot be custom programmed through the RPK4-CH4101. Please refer to the owner's manual of your particular radio for programming instructions.

Custom SWC Programming

Example: To program the **Track Up** button to perform the **Track Up** function with a **quick press**, and perform the **Preset Up** function when the button is **pressed and held** for more than 1 second, from the SWI settings menu, do the following:

Step 1

Open SWI Settings

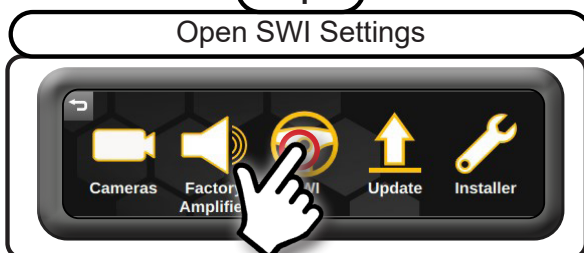

Step 2

Touch the display on the Track Up Long Press function that is currently labeled as Not Assigned.



Setup and Testing (cont.)

Step 3

Scroll to find and press the Preset Up option.



Custom SWC Programming Tips:

- Each SWC radio function can be used only once. If you try to use a radio function that is already assigned to a button, the pre-existing button's radio function will change to "Not Assigned", and the radio function will be set to the new button. For example, if you were to try to program Volume Up to the Mode button, the Volume Up button would now be set to "Not Assigned" and the Mode button would be set to Volume Up.

Audio Adjustments

If your truck has a factory amplifier or parking sensors the 5.2" display has the ability to adjust the factory amplifier's audio settings or the parking sensor chime volume.

Amplifier Audio Settings

Step 1

Open Factory Amplifier Settings

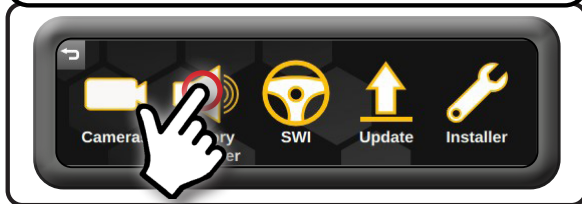

Step 2

Make Adjustments

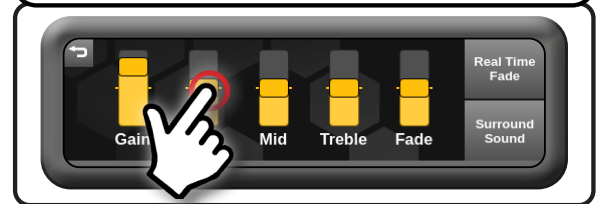

Real Time Fade On = Fading from aftermarket radio
Real Time Fade Off = Fading from this menu only

Chime Volume Adjustment

Step 1- Factory Amplified

Open Advanced Settings

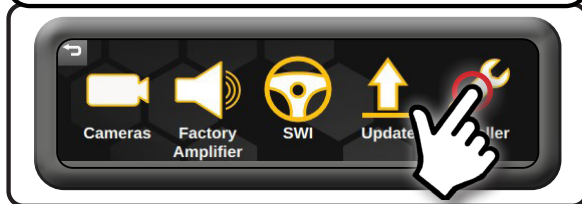

Step 1- Factory Non-Amplified

Open Advanced Settings



Step 2

Adjust Chime Volume



Setup and Testing (cont.)

Hard Buttons

The four hard buttons located below the RPK4-CH4101 display, give you the ability to assign a single preset to each button to control a specific Climate Control function, force activate a specific camera to display on the radio, or to control select screen settings. Once the buttons have been assigned a function, a descriptive tag above each button showing what function that button performs will be present (this function can be toggled on / off).



If popups are turned on in the menu: The proximity sensor within the dash bezel will display the descriptive tabs when your hand is near the buttons. When your hand is removed, the tabs will disappear.

The options that are able to be preset to the hard buttons are:

Climate Control Functions*

- Max A/C
- Sync
- Heated Wheel
- Fan Mode

Camera Functions**

- Camera 1
- Camera 2
- Camera 3
- Camera 4
- Camera 5

Screen Shortcut Functions*

- Climate
- Camera
- Gauges

* Climate Control Functions will vary for Single Zone and Dual Zone applications.

** The number of available cameras will vary based on how many cameras are installed and activated.

Assigning functions to the Hard Buttons

Step 1

Press the Buttons icon in the settings menu

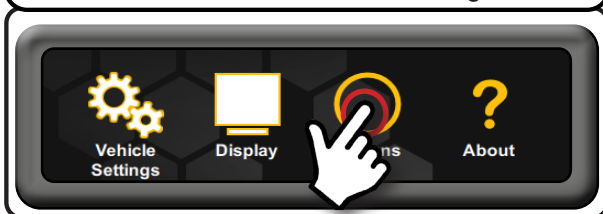

Step 2

Touch the tab that corresponds to the hard button that you wish assign a function to.

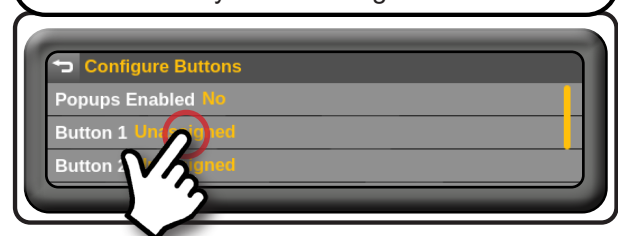

Step 3

Click on the device (Unassigned, Climate Control, Camera) operation you wish to program. In the example, we want to use the first hard button to force activate the cargo camera, so we select the Camera option.

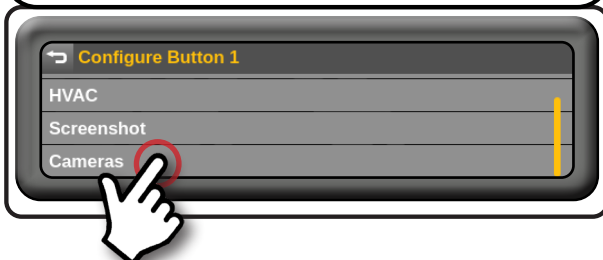

Step 4

In the example, because Camera 5 is the cargo camera, we select the Camera 5 option. Repeat steps 3 through 4 for each hard button you wish to program.

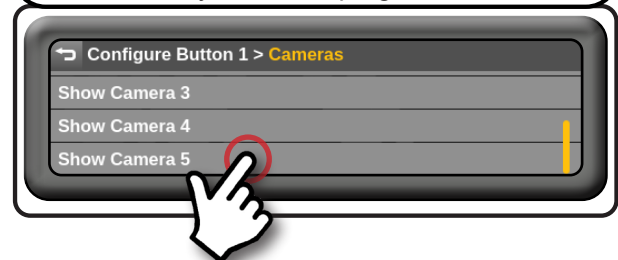

Setup and Testing (cont.)

To test the functionality of the radio and RPK4-CH4101, start with the ignition off and driver's door open, then do the following:

1. Turn the ignition on. The LED on the interface will turn on and the +12v accessory wire will turn on.
2. Turn on the radio and check volume, balance and fade.
 - **If the overall volume is excessively low or high:** Verify that Interface Connector 3 is connected to the appropriate output connector on the RP4.2-CH4101 module (one is for amplified audio systems, the other for non-amplified audio systems).
 - **If the overall volume is slightly lower or higher (trucks with a factory amplifier only):** use the factory amp gain adjustment through the RPK4-CH4101 settings menu to set it to the desired level. See next page for information on how to access the settings menu.
 - Verify that all SWC are functioning properly. See the Steering Wheel Control section (page 15-16) for radio specific details.
3. Verify that all vehicle functions are present through the RPK4-CH4101 5.2" LCD display:
 - **Climate Controls**
 - **Sound Settings** (Only applicable in vehicles with a Factory Amplifier)
 - **SWI Settings** (If DIP Switches are set for any radio other than 2-Wire Resistive)
 - **Vehicle Settings**
 - **Information Screen**
 - **Vehicle Gauges**
 - **Camera Control**
4. **If a vehicle function is not present:** Reset the RP4.2-CH4101 (see page 19). **If a vehicle function is not present after a reset:** With the vehicle running, disconnect and reconnect the RP4.2-CH4101 Display Connector from the back of the 5.2" LCD display then reconnect it.

Troubleshooting

1. **Truck has dual zone Climate Controls but screen is displaying single zone** - With the vehicle running, disconnect and reconnect the RP4.2-CH4101 Display Connector from the back of the 5.2" LCD display.
2. **On initial install, Climate Control fan speed is low fan speed and unresponsive** - The truck needs to be sleep cycled. Turn the truck off, close all doors, lock the truck with the keyfob and let it sit for 5 minutes. After 5 minutes start the truck and check the Climate Control functionality again.
3. **If a vehicle function is not present:** Reset the RP4.2-CH4101 (see page 19). **If a vehicle function is not present after a reset:** With the vehicle running, disconnect and reconnect the RP4.2-CH4101 Display Connector from the back of the 5.2" LCD display then reconnect it.
4. **Steering wheel controls inoperable** - Verify that the DIP switches are set properly according to page 10 of this manual.
5. **Reverse Camera inoperable** - Verify that all reverse camera connection points are proper by reviewing the reverse camera wiring connection steps on page 11 and 12.

LED Pattern	State	Action
LED 2 solid red	Vehicle RAP / ACC output is on	N / A
LED 2 flashing green	SWC Activity	N / A
LED 2 flashing red	Module Resetting / Initializing	N / A
LED 1 solid green	Module Powered and Operating	N / A
LED 1 flashing amber	USB connected	N / A
Off	No Activity	Verify Key is in ignition position. Verify that there is 12v on the Yellow wire and Ground on the Black wires.



Product Updates (Firmware)

Firmware Updates

The RadioPRO app will allow you to update the RP4.2-CH4101 interface with new firmware as it becomes available. Please visit www.PAC-audio.com/firmware for available updates.

The 5.2" LCD screen's firmware can also be updated. Refer to the RPK4.2-CH4101 User Manual for additional information.

To update the firmware, open the Radio PRO PC app, connect the interface to your PC and select "Firmware", then "Update Firmware". Now select "Select File". Finally, browse to the place where you saved the file and select it. This will begin the updating process. Once finished, disconnect the interface from the PC and test operation.

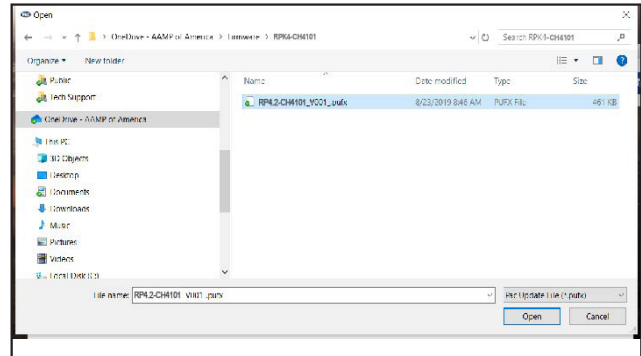

Reset / Restoring Interface Factory Settings

You can restore the interface to factory default settings by pressing and holding the programming button on the side of the module until the status LED starts blinking red. Once the LED starts blinking red, release the button. You must release the button while the LED is blinking red in order to perform the reset. This reset will restore all settings to factory default.

Technical Support

Email: support@PAC-audio.com

Phone: 866-931-8021

International: 727-592-5991

